

# MUR60120

## Ultra Fast Recovery Diodes

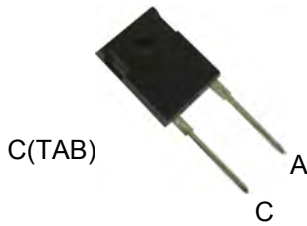

A=Anode, C=Cathode, TAB=Cathode

Dimensions TO-247AC

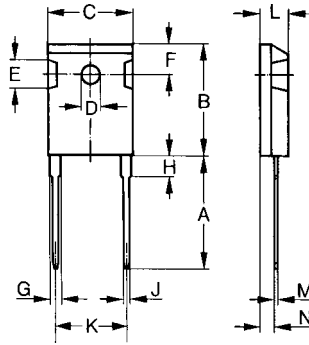

Dim.	Millimeter		Inches	
	Min.	Max.	Min.	Max.
A	19.81	20.32	0.780	0.800
B	20.80	21.46	0.819	0.845
C	15.75	16.26	0.610	0.640
D	3.55	3.65	0.140	0.144
E	4.32	5.49	0.170	0.216
F	5.4	6.2	0.212	0.244
G	1.65	2.13	0.065	0.084
H	-	4.5	-	0.177
J	1.0	1.4	0.040	0.055
K	10.8	11.0	0.426	0.433
L	4.7	5.3	0.185	0.209
M	0.4	0.8	0.016	0.031
N	1.5	2.49	0.087	0.102

	$V_{RSM}$	$V_{RRM}$
	V	V
<b>MUR60120</b>	1200	1200

Symbol	Test Conditions	Maximum Ratings	Unit
$I_{FRMS}$	$T_{VJ}=T_{VJM}$	100	A
$I_{FAVM}$	$T_C=60^\circ\text{C}$ ; rectangular, $d=0.5$	52	
$I_{FRM}$	$t_p < 10\mu\text{s}$ ; rep. rating, pulse width limited by $T_{VJM}$	800	
$I_{FSM}$	$T_{VJ}=45^\circ\text{C}$	$t=10\text{ms}$ (50Hz), sine $t=8.3\text{ms}$ (60Hz), sine	A
	$T_{VJ}=150^\circ\text{C}$	$t=10\text{ms}$ (50Hz), sine $t=8.3\text{ms}$ (60Hz), sine	
$I^2t$	$T_{VJ}=45^\circ\text{C}$	$t=10\text{ms}$ (50Hz), sine $t=8.3\text{ms}$ (60Hz), sine	$\text{A}^2\text{s}$
	$T_{VJ}=150^\circ\text{C}$	$t=10\text{ms}$ (50Hz), sine $t=8.3\text{ms}$ (60Hz), sine	
$T_{VJ}$		-40...+150	$^\circ\text{C}$
$T_{VJM}$		150	
$T_{stg}$		-40...+150	
$P_{tot}$	$T_C=25^\circ\text{C}$	189	W
$M_d$	Mounting torque	0.8...1.2	Nm
Weight		6	g

**Sirectifier**<sup>®</sup>

# MUR60120

## Ultra Fast Recovery Diodes

Symbol	Test Conditions	Characteristic Values		Unit
		typ.	max.	
<b>I<sub>R</sub></b>	$T_{VJ}=25^{\circ}\text{C}; V_R=V_{RRM}$		2.2	mA
	$T_{VJ}=25^{\circ}\text{C}; V_R=0.8 \cdot V_{RRM}$		0.5	
	$T_{VJ}=125^{\circ}\text{C}; V_R=0.8 \cdot V_{RRM}$		14	
<b>V<sub>F</sub></b>	$I_F=60\text{A}; T_{VJ}=150^{\circ}\text{C}$		2.0	V
	$T_{VJ}=25^{\circ}\text{C}$		2.55	
<b>V<sub>TO</sub></b>	For power-loss calculations only		1.65	V
<b>r<sub>T</sub></b>	$T_{VJ}=T_{VJM}$		8.3	m $\Omega$
<b>R<sub>thJC</sub></b> <b>R<sub>thCK</sub></b> <b>R<sub>thJA</sub></b>		0.25	0.66	K/W
			35	
<b>t<sub>rr</sub></b>	$I_F=1\text{A}; -di/dt=200\text{A}/\mu\text{s}; V_R=30\text{V}; T_{VJ}=25^{\circ}\text{C}$	40	60	ns
<b>I<sub>RM</sub></b>	$V_R=540\text{V}; I_F=60\text{A}; -di_F/dt=480\text{A}/\mu\text{s}; L \leq 0.05\mu\text{H}; T_{VJ}=100^{\circ}\text{C}$	32	36	A

### FEATURES

- \* International standard package JEDEC TO-247AC
- \* Glass passivated chips
- \* Very short recovery time
- \* Extremely low switching losses
- \* Low I<sub>RM</sub>-values
- \* Soft recovery behaviour
- \* RoHS compliant

### APPLICATIONS

- \* Antiparallel diode for high frequency switching devices
- \* Antisaturation diode
- \* Snubber diode
- \* Free wheeling diode in converters and motor control circuits
- \* Rectifiers in switch mode power supplies (SMPS)
- \* Inductive heating and melting
- \* Uninterruptible power supplies (UPS)
- \* Ultrasonic cleaners and welders

### ADVANTAGES

- \* High reliability circuit operation
- \* Low voltage peaks for reduced protection circuits
- \* Low noise switching
- \* Low losses
- \* Operating at lower temperature or space saving by reduced cooling



# MUR60120

## Ultra Fast Recovery Diodes

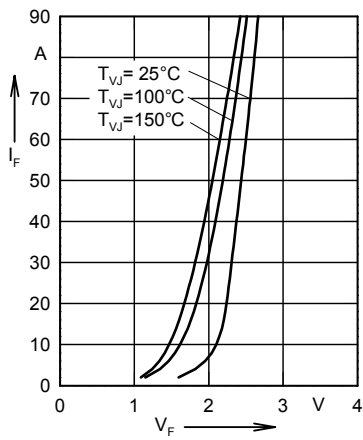

Fig. 1 Forward current versus voltage drop.

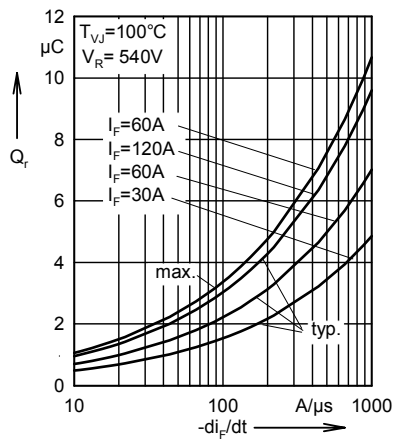

Fig. 2 Recovery charge versus  $-di_F/dt$ .

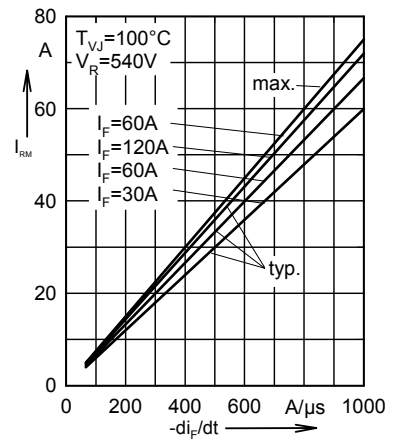

Fig. 3 Peak reverse current versus  $-di_F/dt$ .

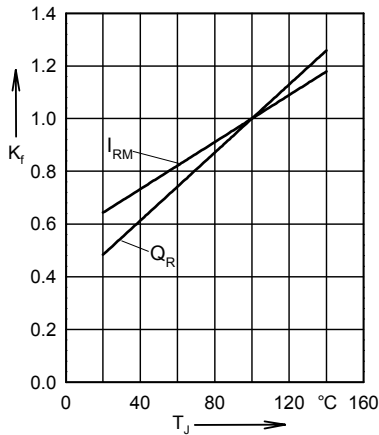

Fig. 4 Dynamic parameters versus junction temperature.

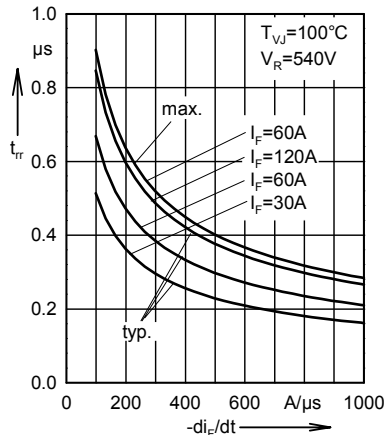

Fig. 5 Recovery time versus  $-di_F/dt$ .

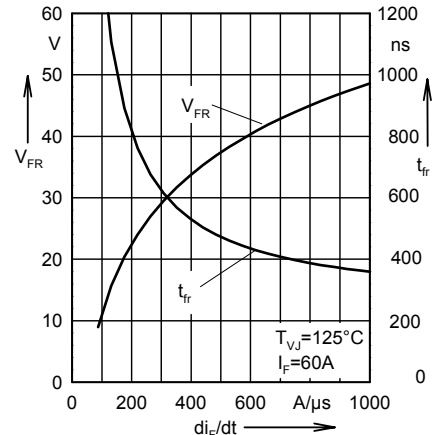

Fig. 6 Peak forward voltage versus  $di_F/dt$ .

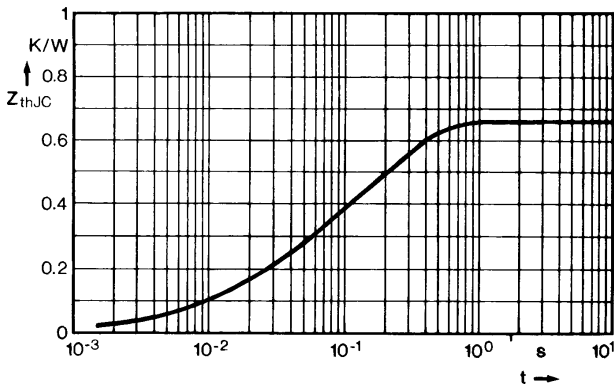

Fig. 7 Transient thermal impedance junction to case.

