

# S3PDB- - NXX

## Three Phase Rectifier Modules

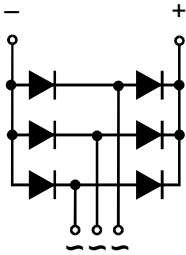

Type	V <sub>RSM</sub> V	V <sub>RRM</sub> V
S3PDB- - N08	900	800
S3PDB- - N12	1300	1200
S3PDB- - N14	1500	1400
S3PDB- - N16	1700	1600
S3PDB- - N18	1900	1800

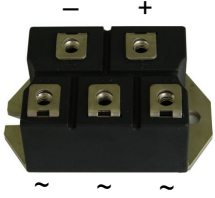

[ul.com/rscs](http://ul.com/rscs)

Dimensions in mm (1mm=0.0394")

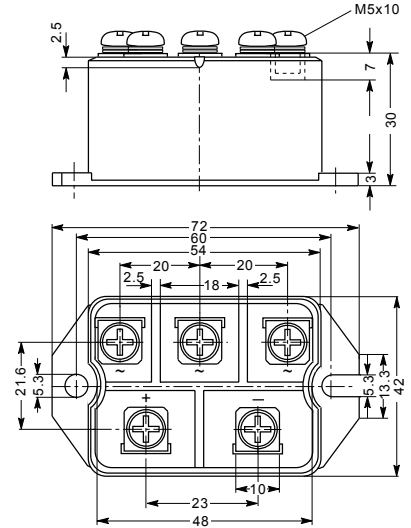

Symbol	Test Conditions	Maximum Ratings	Unit
I <sub>dav</sub>	T <sub>C</sub> =100°C, module	100	A
I <sub>dav</sub>	T <sub>A</sub> =35°C (R <sub>thCA</sub> =0.2K/W), module	91	
I <sub>FSM</sub>	T <sub>VJ</sub> =45°C V <sub>R</sub> =0 t=10ms (50Hz), sine t=8.3ms (60Hz), sine	920 1000	A
	T <sub>VJ</sub> =T <sub>VJM</sub> V <sub>R</sub> =0 t=10ms(50Hz), sine t=8.3ms(60Hz), sine	770 850	
I <sup>2</sup> t	T <sub>VJ</sub> =45°C V <sub>R</sub> =0 t=10ms (50Hz), sine t=8.3ms (60Hz), sine	5500 5500	A <sup>2</sup> s
	T <sub>VJ</sub> =T <sub>VJM</sub> V <sub>R</sub> =0 t=10ms(50Hz), sine t=8.3ms(60Hz), sine	3800 3800	
T <sub>VJ</sub> T <sub>VJM</sub> T <sub>stg</sub>		-40...+150 150 -40...+125	°C
V <sub>ISOL</sub>	50/60Hz, RMS I <sub>ISOL</sub> ≤1mA t=1min t=1s	2500 3000	V~
M <sub>d</sub>	Mounting torque (M5) Terminal connection torque (M5)	5 ± 15% 5 ± 15%	Nm
Weight	typical	160	g

**Sirectifier®**

# S3PDB99NXX

## Three Phase Rectifier Modules

Symbol	Test Conditions	Characteristic Values	Unit
$I_R$	$V_R=V_{RRM}; T_{VJ}=25^{\circ}C$ $V_R=V_{RRM}; T_{VJ}=T_{VJM}$	$\leq 0.3$ $\leq 5$	mA
$V_F$	$I_F=100A; T_{VJ}=25^{\circ}C$	$\leq 1.20$	V
$V_{TO}$	For power-loss calculations only	0.8	V
$r_T$	$T_{VJ}=T_{VJM}$	4	$m\Omega$
$R_{thJC}$	per diode per module	1.40 0.23	K/W
$R_{thJK}$	per diode per module	1.80 0.30	K/W
$d_s$	Creeping distance on surface	10	mm
$d_A$	Creepage distance in air	9.4	mm
$a$	Max. allowable acceleration	50	$m/s^2$

### FEATURES

- \* Package with screw terminals
- \* Isolation voltage 3000 V~
- \* Glass passivated chips
- \* Blocking voltage up to 1800 V
- \* Low forward voltage drop
- \* UL File NO.E310749
- \* RoHS compliant

### APPLICATIONS

- \* Supplies for DC power equipment
- \* Input rectifiers for PWM inverter
- \* Battery DC power supplies
- \* Field supply for DC motors

### ADVANTAGES

- \* Easy to mount with two screws
- \* Space and weight savings
- \* Improved temperature and power cycling



# S3PDB99NXX

## Three Phase Rectifier Modules

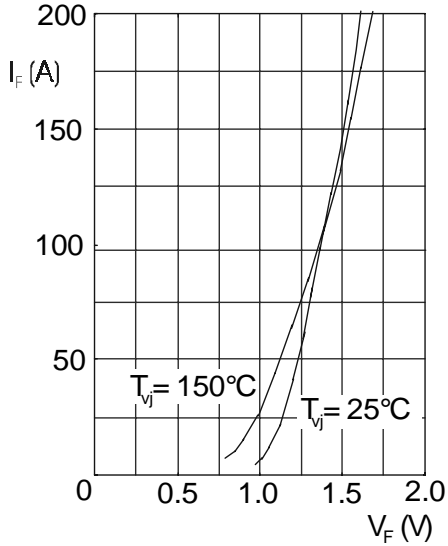

Forward current versus voltage drop per diode

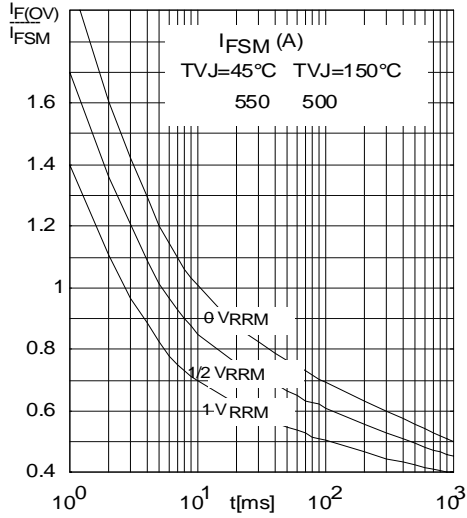

Surge overload current per diode  $I_{FSM}$ : Crest value  
t: duration

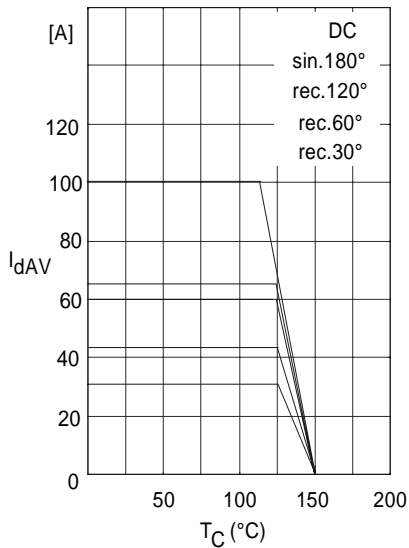

Maximum forward current at case temperature

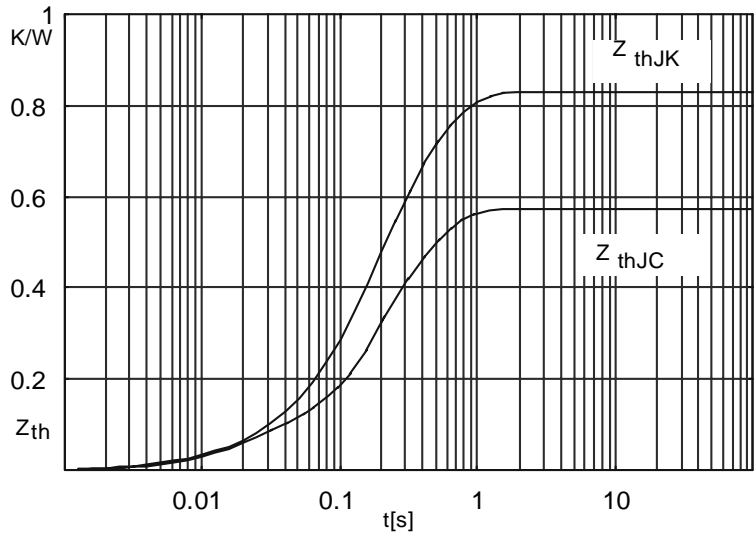

Transient thermal impedance per diode

