

S3PDB80NXX

Three Phase Rectifier Modules

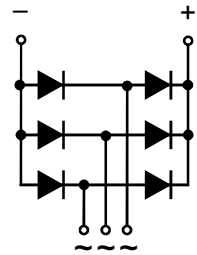

Type	V _{RSM} V	V _{RSM} V
S3PDB80N08	900	800
S3PDB80N12	1300	1200
S3PDB80N14	1500	1400
S3PDB80N16	1700	1600
S3PDB80N18	1900	1800

Dimensions in mm (1mm=0.0394")

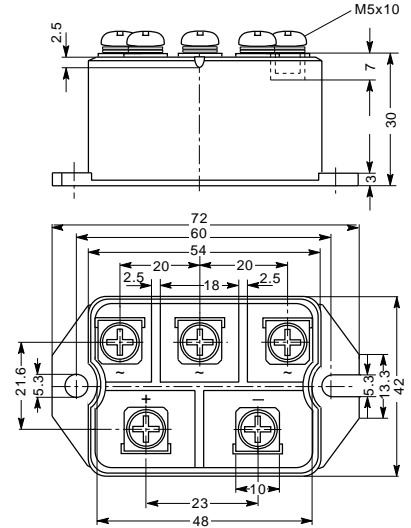

Symbol	Test Conditions	Maximum Ratings	Unit
I _{dav}	T _C =110°C, module	80	A
I _{dav}	T _A =45°C (R _{thCA} =0.6K/W), module	57	
I _{FSM}	T _{VJ} =45°C V _R =0 t=10ms (50Hz), sine t=8.3ms (60Hz), sine	750 820	A
	T _{VJ} =T _{VJM} V _R =0 t=10ms(50Hz), sine t=8.3ms(60Hz), sine	670 740	
I ² t	T _{VJ} =45°C V _R =0 t=10ms (50Hz), sine t=8.3ms (60Hz), sine	2800 3370	A ² s
	T _{VJ} =T _{VJM} V _R =0 t=10ms(50Hz), sine t=8.3ms(60Hz), sine	2250 2710	
T _{VJ} T _{VJM} T _{stg}		-40...+150 150 -40...+125	°C
V _{ISOL}	50/60Hz, RMS I _{ISOL} ≤1mA t=1min t=1s	2500 3000	V~
M _d	Mounting torque (M5) Terminal connection torque (M5)	5 ± 15% 5 ± 15%	Nm
Weight	typ.	160	g



S3PDB80NXX

Three Phase Rectifier Modules

Symbol	Test Conditions	Characteristic Values	Unit
I_R	$V_R=V_{RRM}; T_{VJ}=25^{\circ}C$ $V_R=V_{RRM}; T_{VJ}=T_{VJM}$	≤ 0.3 ≤ 5	mA
V_F	$I_F=150A; T_{VJ}=25^{\circ}C$	≤ 1.6	V
V_{TO}	For power-loss calculations only	0.8	V
r_T	$T_{VJ}=T_{VJM}$	5	$m\Omega$
R_{thJC}	per diode per module	1.1 0.183	K/W
R_{thJK}	per diode per module	1.52 0.253	K/W
d_s	Creeping distance on surface	10	mm
d_A	Creepage distance in air	9.4	mm
a	Max. allowable acceleration	50	m/s^2

FEATURES

- * Package with screw terminals
- * Isolation voltage 3000 V~
- * Glass passivated chips
- * Blocking voltage up to 1800 V
- * Low forward voltage drop
- * UL File No. 310749
- * RoHs Compliant

APPLICATIONS

- * Supplies for DC power equipment
- * Input rectifiers for PWM inverter
- * Battery DC power supplies
- * Field supply for DC motors

ADVANTAGES

- * Easy to mount with two screws
- * Space and weight savings
- * Improved temperature and power cycling

Sirectifier[®]

S3PDB80NXX

Three Phase Rectifier Modules

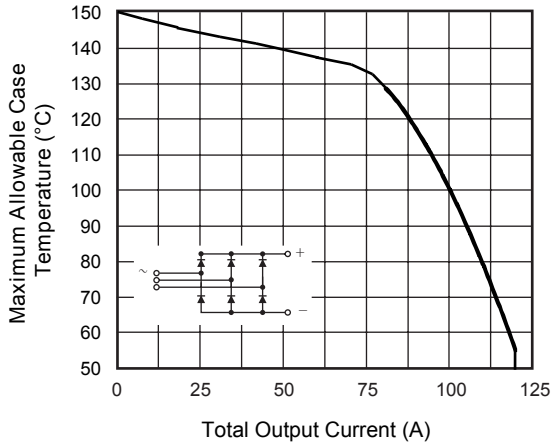

Fig. 1 - Current Ratings Characteristic

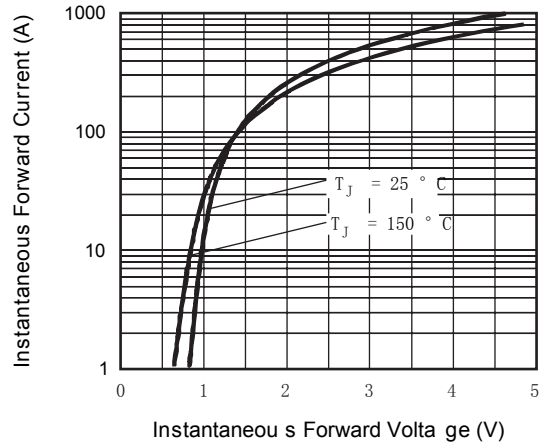

Fig. 2 - Forward Voltage Drop Characteristics

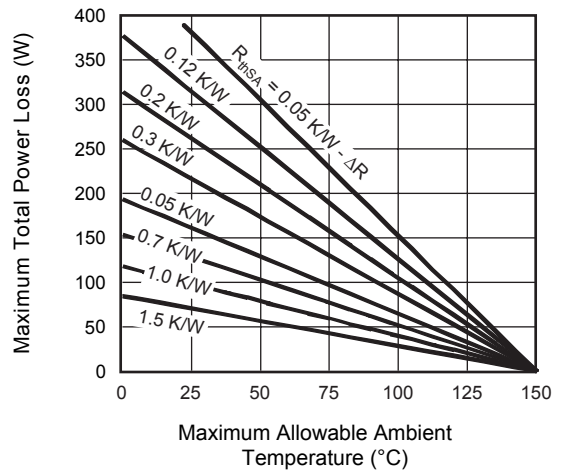
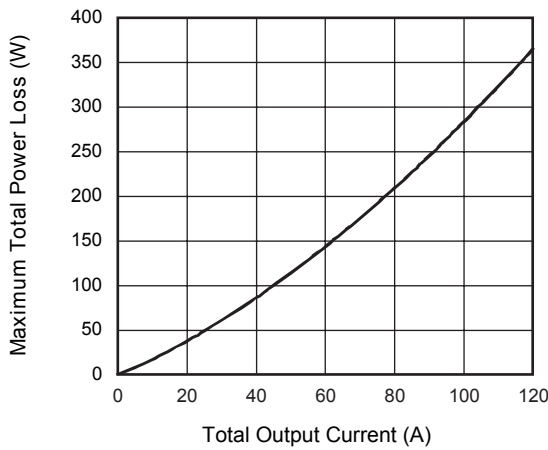

Fig. 3 - Total Power Loss Characteristics

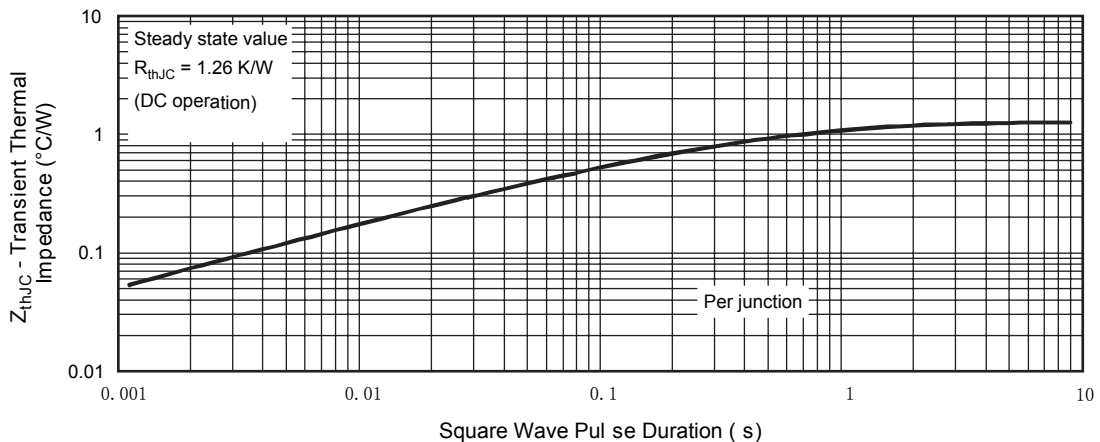

Fig.4 - Thermal Impedance Z_{thJC} Characteristic

