

S3PDB35NXX

High Voltage Phase Bridge Rectifiers

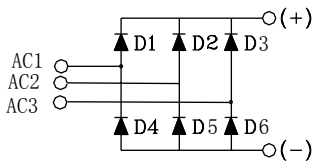

Dimensions in mm (1mm=0.0394")

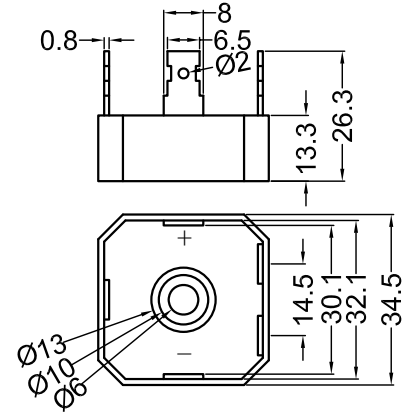

Type	V _{RSM} V	V _{RSM} V
S3PDB35N06	700	600
S3PDB35N08	900	800
S3PDB35N12	1300	1200
S3PDB35N14	1500	1400
S3PDB35N16	1700	1600

Symbol	Test Conditions	Maximum Ratings	Unit
I _{dav}	T _C =55°C, module	35	A
I _{FSM}	T _{VJ} =45°C V _R =0 t=10ms (50Hz), sine t=8.3ms (60Hz), sine	310 400	A
	T _{VJ} =T _{VJM} V _R =0 t=10ms(50Hz), sine t=8.3ms(60Hz), sine	275 350	
I ² t	T _{VJ} =45°C V _R =0 t=10ms (50Hz), sine t=8.3ms (60Hz), sine	1350 1200	A ² s
	T _{VJ} =T _{VJM} V _R =0 t=10ms(50Hz), sine t=8.3ms(60Hz), sine	1130 1030	
T _{VJ} T _{VJM} T _{stg}		-55...+150 150 -55...+125	°C
V _{ISOL}	50/60Hz, RMS I _{ISOL} ≤1mA t=1min t=1s	2500 3000	V~
M _d	Mounting torque (M4)	2 ± 15%	Nm
Weight	typ.	22	g



S3PDB35NXX

Half-Wave Bridge Rectifier

Symbol	Test Conditions	Characteristic Values	Unit
I_R	$V_R=V_{RRM}; T_{VJ}=25^{\circ}C$ $V_R=V_{RRM}; T_{VJ}=T_{VJM}$	≤ 5 ≤ 1000	μA
V_F	$I_F=12A; T_{VJ}=25^{\circ}C$	≤ 1.1	V
V_{TO}	For power-loss calculations only	0.8	V
r_T	$T_{VJ}=T_{VJM}$	3.867	$m\Omega$
R_{thJC}	per diode per module	1.3 0.325	K/W
R_{thJK}	per diode per module	1.5 0.375	K/W
d_s	Creeping distance on surface	10	mm
d_A	Creepage distance in air	9.4	mm
a	Max. allowable acceleration	50	m/s^2

FEATURES

- * Rating to 1600V PRV
- * High efficiency
- * Glass passivated chip junction
- * Electrically isolated metal case for maximum heat dissipation

APPLICATIONS

- * Supplies for DC power equipment
- * Input rectifiers for PWM inverter
- * Battery DC power supplies
- * Field supply for DC motors

ADVANTAGES

- * Easy to mount one screw
- * Space and weight savings
- * Improved temperature and power cycling



S3PDB35NXX

Three Phase Bridge Rectifiers

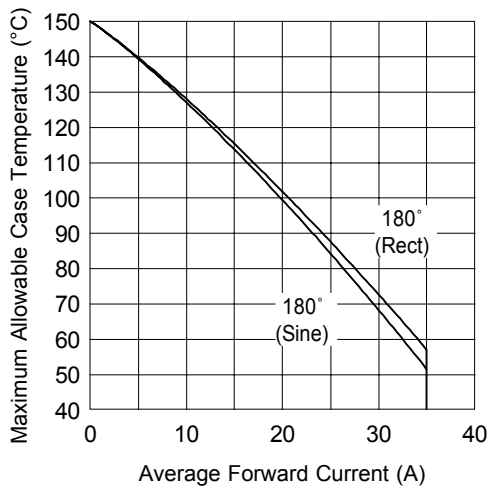

Fig. 1 - Current Ratings Characteristics

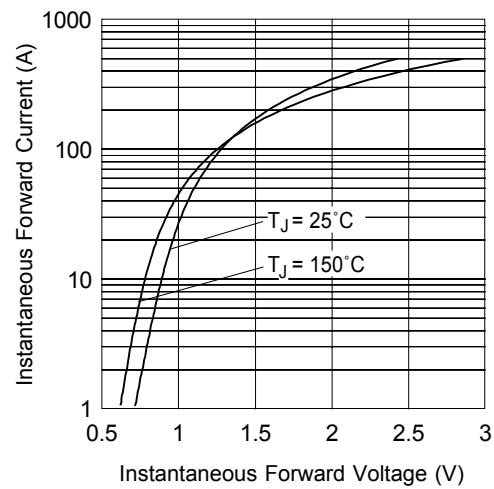

Fig. 2 - Forward Voltage Drop Characteristics

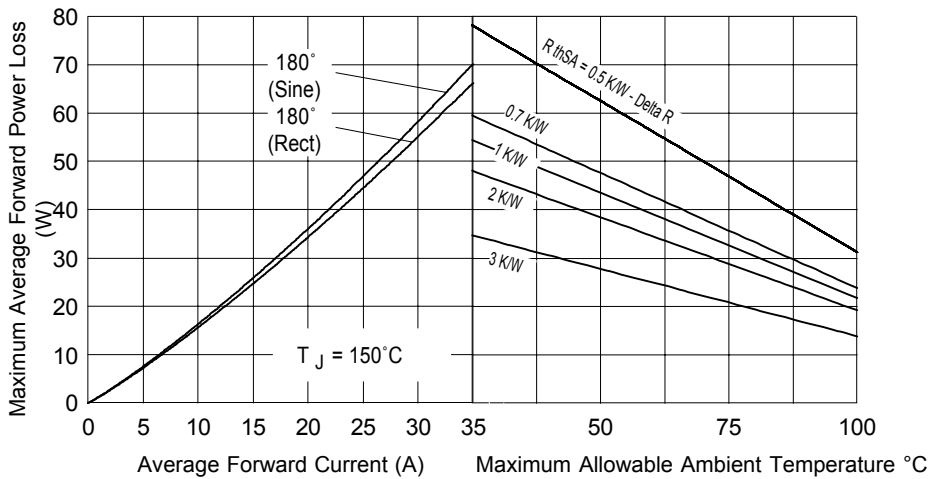

Fig. 3 - Total Power Loss Characteristics

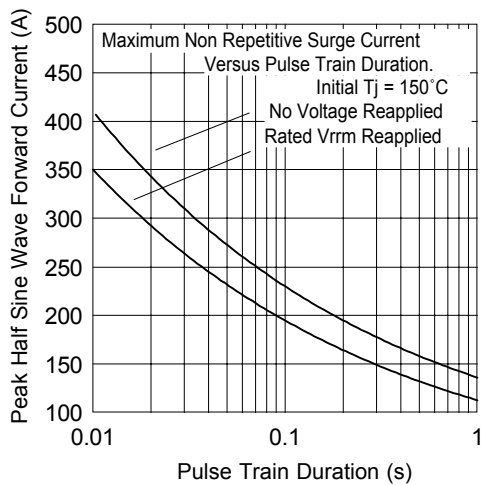

Fig. 4 - Maximum Non-Repetitive Surge Current

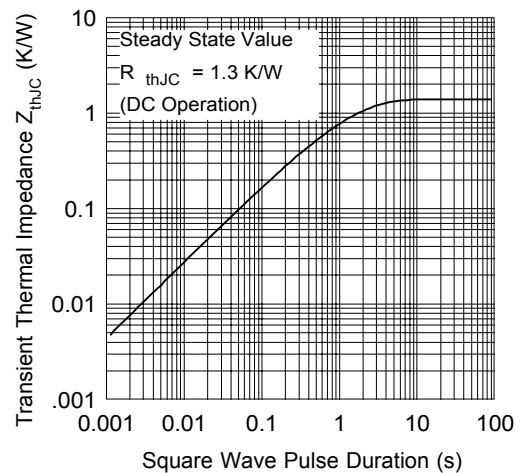

Fig. 5 - Thermal Impedance Z_{thJC} Characteristic

