

# STT49GKxx

## Thyristor-Thyristor Modules

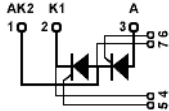
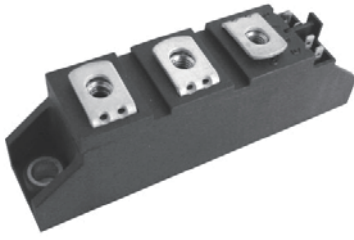

Type	$V_{RSM}$ $V_{DSM}$ V	$V_{RRM}$ $V_{DRM}$ V
STT49GK08	900	800
STT49GK12	1300	1200
STT49GK14	1500	1400
STT49GK16	1700	1600
STT49GK18	1900	1800

Dimensions in mm (1mm=0.0394")

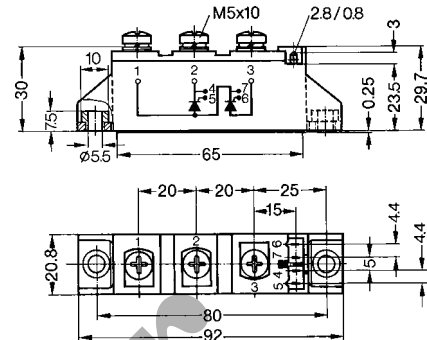

Symbol	Test Conditions	Maxmum Ratings	Unit
$I_{TRMS}, I_{FRMS}$ $I_{TAVM}, I_{FAVM}$	$T_{VJ}=T_{VJM}$ $T_C=85^{\circ}C; 180^{\circ}$ sine	80 49	A
$I_{TSM}, I_{FSM}$	$T_{VJ}=45^{\circ}C$ $V_R=0$ $t=10ms$ (50Hz), sine $t=8.3ms$ (60Hz), sine	1150 1230	A
	$T_{VJ}=T_{VJM}$ $V_R=0$ $t=10ms$ (50Hz), sine $t=8.3ms$ (60Hz), sine	1000 1070	
$\int i^2 dt$	$T_{VJ}=45^{\circ}C$ $V_R=0$ $t=10ms$ (50Hz), sine $t=8.3ms$ (60Hz), sine	6600 6280	$A^2s$
	$T_{VJ}=T_{VJM}$ $V_R=0$ $t=10ms$ (50Hz), sine $t=8.3ms$ (60Hz), sine	5000 4750	
$(di/dt)_{cr}$	$T_{VJ}=T_{VJM}$ $f=50Hz, t_p=200us$ $V_D=2/3V_{DRM}$ $I_G=0.45A$ $di_G/dt=0.45A/us$	repetitive, $I_T=150A$ 150	A/us
		non repetitive, $I_T=I_{TAVM}$ 500	
$(dv/dt)_{cr}$	$T_{VJ}=T_{VJM};$ $R_{GK}=\infty$ ; method 1 (linear voltage rise)	$V_{DR}=2/3V_{DRM}$ 1000	V/us
$P_{GM}$	$T_{VJ}=T_{VJM}$ $I_T=I_{TAVM}$	$t_p=30us$ 10	W
		$t_p=300us$ 5	
$P_{GAV}$		0.5	W
$V_{RGM}$		10	V
$T_{VJ}$ $T_{VJM}$ $T_{stg}$		-40...+125	$^{\circ}C$
		125	
		-40...+125	
$V_{ISOL}$	50/60Hz, RMS $I_{ISOL} \leq 1mA$	$t=1min$ 3000	V~
		$t=1s$ 3600	
$M_d$	Mounting torque (M5)	2.5-4.0/22-35	Nm/lb.in.
	Terminal connection torque (M5)	2.5-4.0/22-35	
Weight	Typ.	81	g

# STT49GKxx

## Thyristor-Thyristor Modules

Symbol	Test Conditions	Characteristic Values	Unit
$I_{RRM}, I_{DRM}$	$T_{VJ}=T_{VJM}; V_R=V_{RRM}; V_D=V_{DRM}$	5	mA
$V_T, V_F$	$I_T, I_F=200A; T_{VJ}=25^{\circ}C$	1.75	V
$V_{TO}$	For power-loss calculations only ( $T_{VJ}=125^{\circ}C$ )	0.85	V
$r_T$		5.3	$m\Omega$
$V_{GT}$	$V_D=6V; T_{VJ}=25^{\circ}C$ $T_{VJ}=-40^{\circ}C$	1.5 1.6	V
$I_{GT}$	$V_D=6V; T_{VJ}=25^{\circ}C$ $T_{VJ}=-40^{\circ}C$	100 200	mA
$V_{GD}$	$T_{VJ}=T_{VJM}; V_D=2/3V_{DRM}$	0.2	V
$I_{GD}$		10	mA
$I_L$	$T_{VJ}=25^{\circ}C; t_p=10\mu s; V_D=6V$ $I_G=0.45A; di_G/dt=0.45A/\mu s$	450	mA
$I_H$	$T_{VJ}=25^{\circ}C; V_D=6V; R_{GK}=\infty$	200	mA
$t_{gd}$	$T_{VJ}=25^{\circ}C; V_D=1/2V_{DRM}$ $I_G=0.45A; di_G/dt=0.45A/\mu s$	2	$\mu s$
$t_q$	$T_{VJ}=T_{VJM}; I_T=120A; t_p=200\mu s; -di/dt=10A/\mu s$ $V_R=100V; dv/dt=20V/\mu s; V_D=2/3V_{DRM}$	typ. 150	$\mu s$
$Q_s$	$T_{VJ}=T_{VJM}; I_T, I_F=50A; -di/dt=0.64A/\mu s$	90	$\mu C$
$I_{RM}$		11	A
$R_{thJC}$	per thyristor/diode; DC current per module	0.53 0.265	K/W
$R_{thJK}$	per thyristor/diode; DC current per module	0.73 0.365	K/W
$d_s$	Creeping distance on surface	12.7	mm
$d_A$	Strike distance through air	9.6	mm
$a$	Maximum allowable acceleration	50	$m/s^2$

### FEATURES

- \* International standard package
- \* Copper base plate
- \* Glass passivated chips
- \* Isolation voltage 3600 V~
- \* UL file NO.310749
- \* RoHs compliance

### APPLICATIONS

- \* DC motor control
- \* Softstart AC motor controller
- \* Light, heat and temperature control

### ADVANTAGES

- \* Space and weight savings
- \* Simple mounting with two screws
- \* Improved temperature and power cycling
- \* Reduced protection circuits

# STT49GKxx

## Thyristor-Thyristor Modules

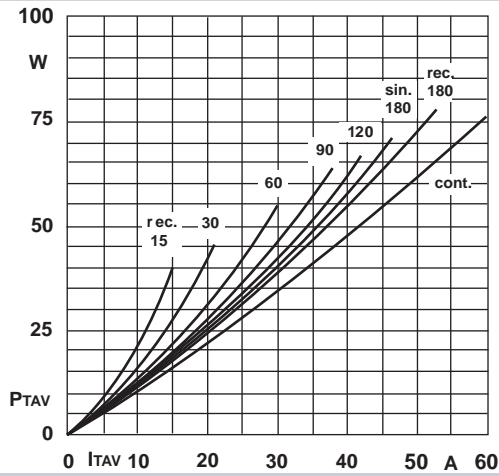

Fig.1L Power dissipation per thyristor vs. on-state current

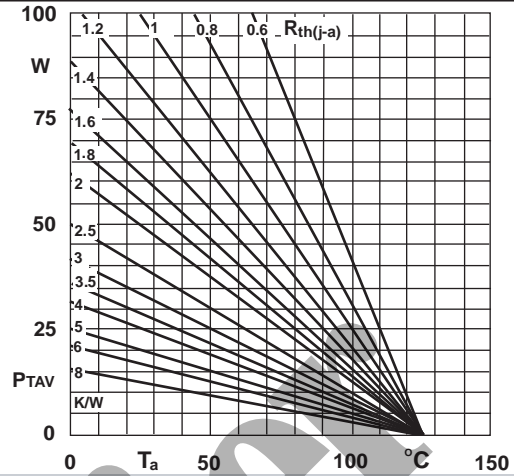

Fig.1R Power dissipation per thyristor vs. ambient temp

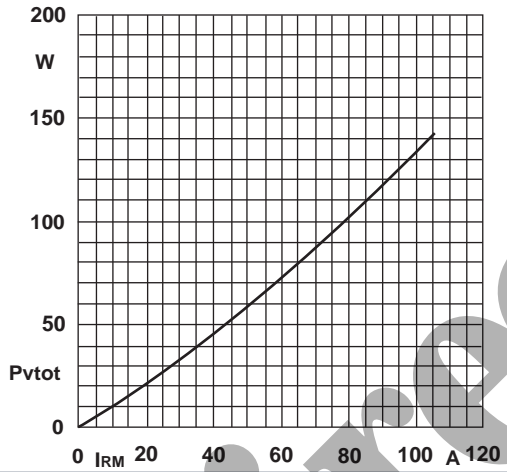

Fig.2L Power dissipation per module vs. rms current

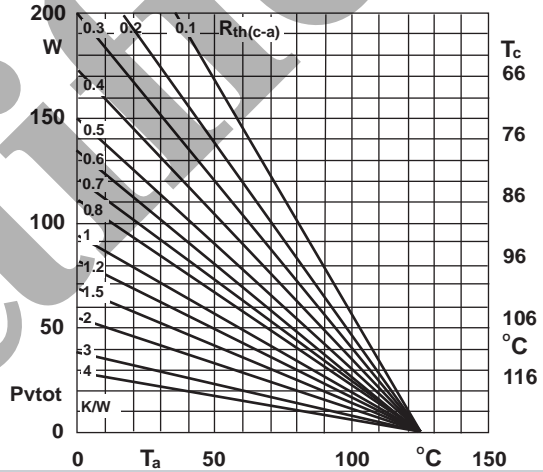

Fig.2R Power dissipation per module vs. case temp

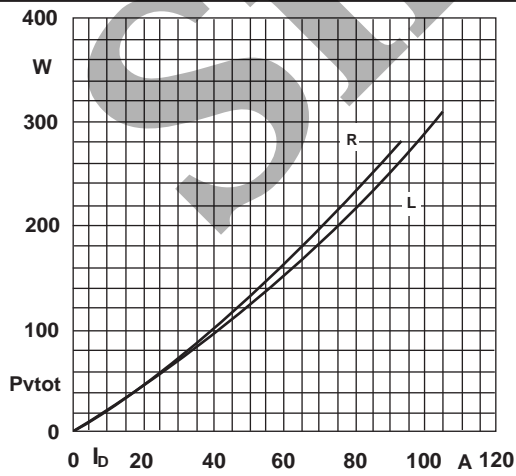

Fig.3L Power dissipation of two modules vs. direct current

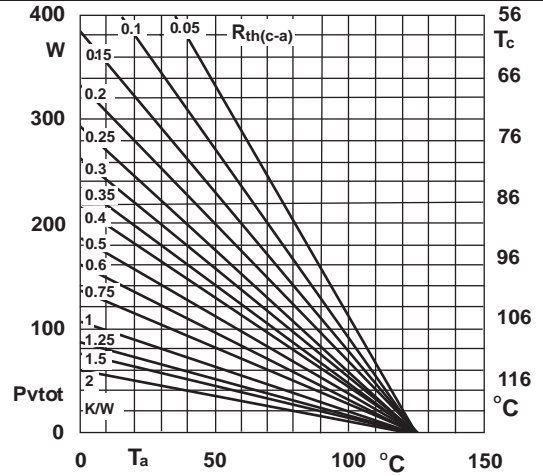

Fig.3R Power dissipation of two modules vs. case temp

# STT49GKxx

## Thyristor-Thyristor Modules

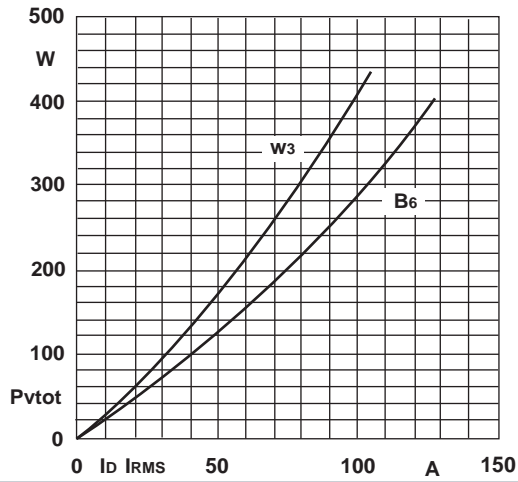

Fig.4L Power dissipation of three modules vs. direct and rms current

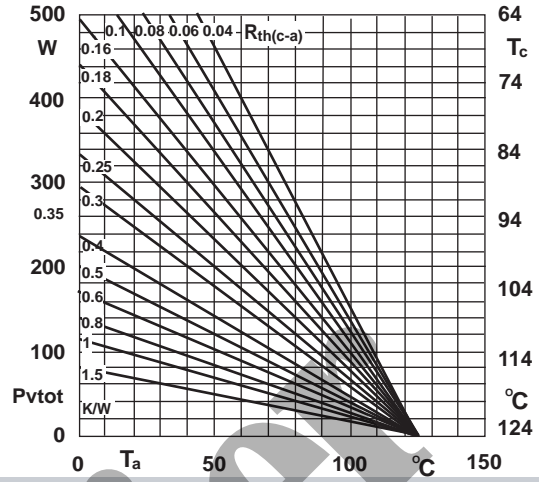

Fig.4R Power dissipation of three modules vs. case temp

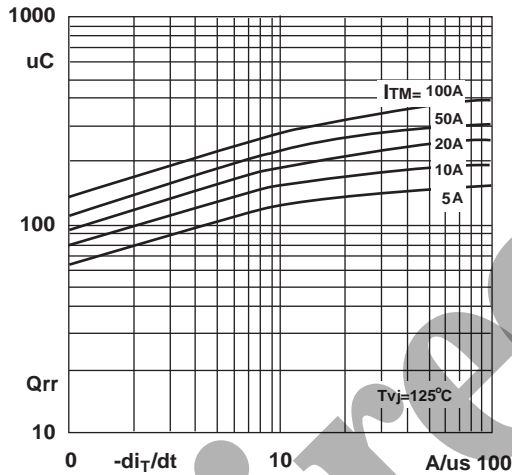

Fig.5 Recovered charge vs. current decrease

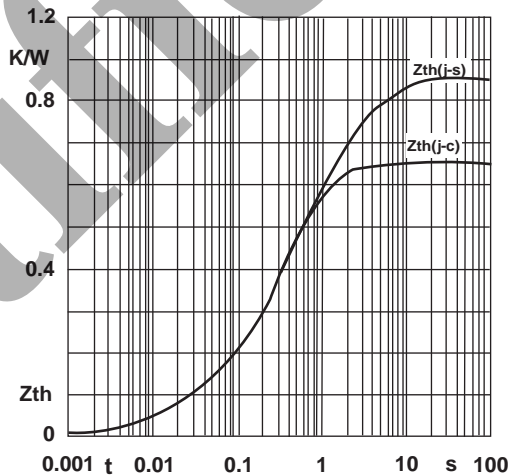

Fig.6 Transient thermal impedance vs. time

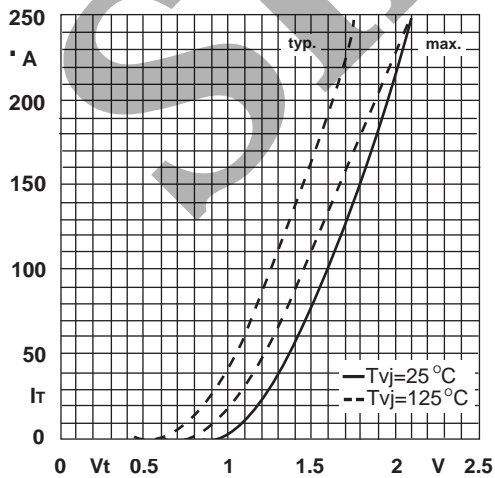

Fig.7 On-state characteristics

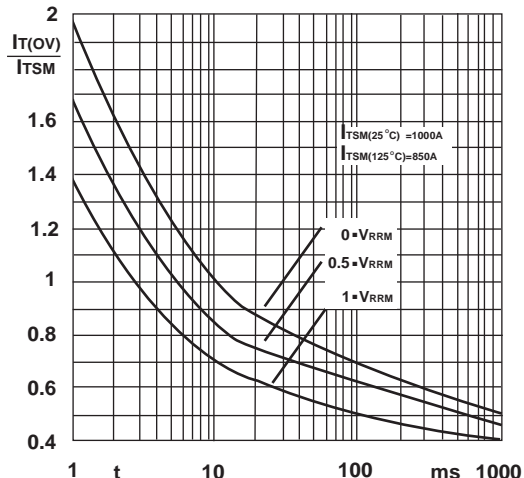

Fig.8 Surge overload current vs. time